

**COLLAPSIBLE MOBILE LEADED BARRIER
WITH 24" X 24" WINDOW**

PRODUCT INFORMATION

PHILLIPS-SAFETY.COM

COPYRIGHT ©2025. ALL RIGHTS RESERVED



**PHILLIPS SAFETY
PRODUCTS INC.**

PRODUCT INFORMATION

COLLAPSIBLE MOBILE LEADED BARRIER WITH 24" X 24" WINDOW



The Collapsible Mobile Leaded Barrier with 24" x 24" Window is a portable full-body radiation barrier for protection against secondary radiation. It travels easily on four casters, two with brakes, and features a screen that can be easily raised and lowered by hand. This Phillips Safety radiation barrier has a 0.50mm lead equivalent lightweight leaded acrylic window and a 2.0mm lead equivalent steel and lead frame. Its overall size is 29.9" W x 74.4" H.

SPECIFICATION

BARRIER MATERIAL: Metal

FEATURES: Lead window, four casters, two brakes

OVERALL SIZE: 29.9"W x 74.7"H

PROTECTION LEVEL: 2.0mm PbEq

WINDOW MATERIAL: Acrylic

WINDOW PROTECTION LEVEL: 0.5mm PbEq

WINDOW SIZE: 24" x 24"

PRODUCT INFORMATION
COLLAPSIBLE MOBILE LEADED BARRIER WITH 24" X 24" WINDOW

COLLAPSIBLE MOBILE BARRIER

FRONT

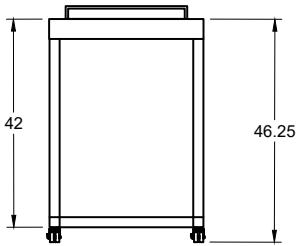

SIDE

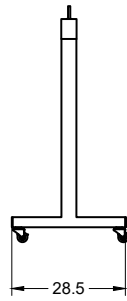

EXPANDED IMAGE

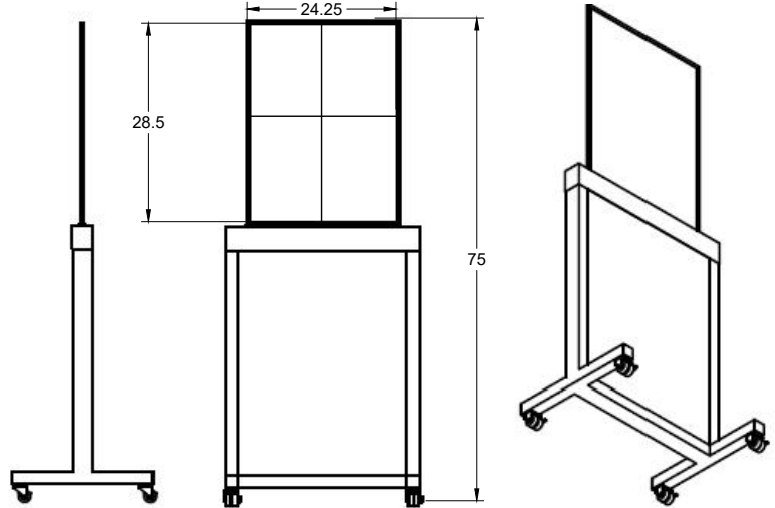

PERSPECTIVE

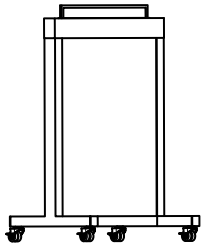

TOP

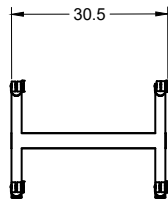

All the dimensions are in Inches otherwise Specified

PROJECT
LB-7429
 TITLE
PHILLIPS SAFETY PRODUCTS INC

| | | | | |
|------------------------------|-----------|--------|-----------|-----|
| APPROVED | SIZE | CODE | DWG NO | REV |
| CHECKED | B | | | |
| DRAWN Ryan Phillips 5/9/2024 | SCALE 1:1 | WEIGHT | SHEET 1/1 | |

PRODUCT INFORMATION

COLLAPSIBLE MOBILE LEADED BARRIER WITH 24" X 24" WINDOW

CONTACT

Should you need any further information,
please do not hesitate to contact us.

123 Lincoln Blvd, Middlesex, NJ 08846, USA 

+1 866 575 1307 

service@phillips-safety.com 

www.phillips-safety.com 