

# WALL MOUNTED LEAD APRON PEG RACK

PRODUCT INFORMATION

PHILLIPS-SAFETY.COM

COPYRIGHT ©2025. ALL RIGHTS RESERVED



**PHILLIPS SAFETY**  
PRODUCTS INC.

**PRODUCT INFORMATION**  
WALL MOUNTED LEAD APRON PEG RACK

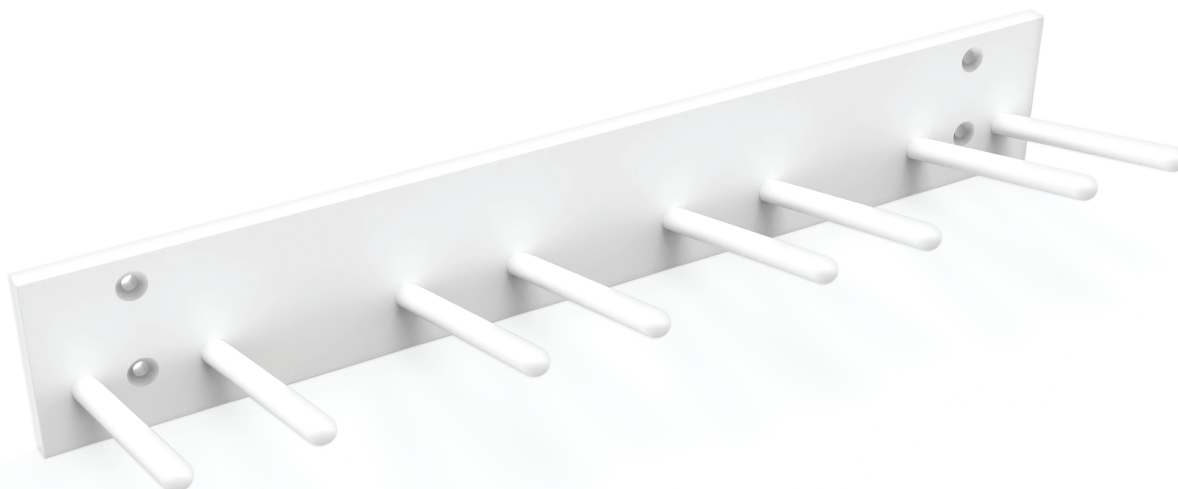

The Wall Mounted Lead Apron Peg Rack is a strong lead apron rack made of heavy gauge steel with an electro-magnetic powder coating. When securely mounted to a wall, this Phillips Safety rack can hold anywhere from 1 to 9 aprons, depending on your needs. It is available in five different sizes, for 1, 2, 4, 7, or 9 lead aprons.

**SPECIFICATION**

---

**COLOR:** White

**FEATURES:** Wall mounted, eletro-magnetic powder coating

**MATERIAL:** Steel

**LEAD APRON CAPACITY:** 1 - 9

**SIZE:** 5 variations

**WEIGHT:** 2.2 lb - 18 lb

# RAR-P1

Top

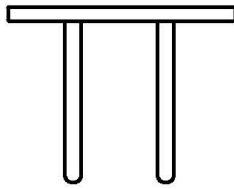

Perspective

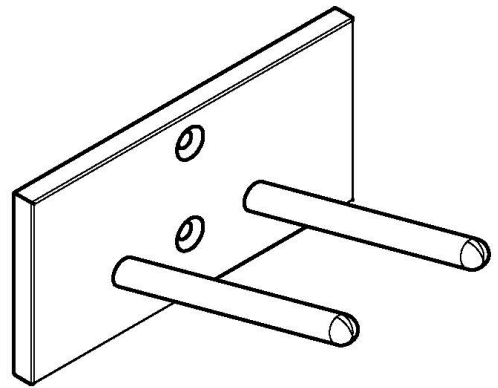

Front

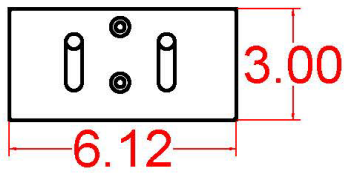

Side

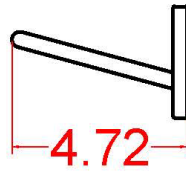

RAR-P1  
SCALE: 3" = 1'

# RAR-P2

Top

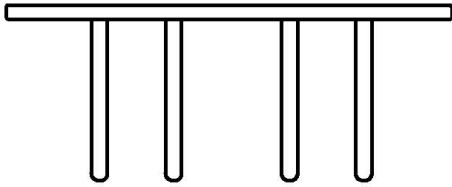

Perspective

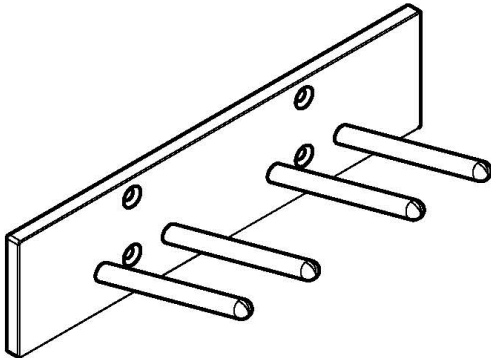

Front

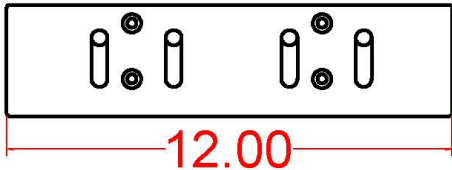

Side

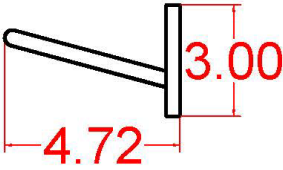

**RAR-P2**  
**SCALE: 3" = 1'**



# RAR-P4

Top

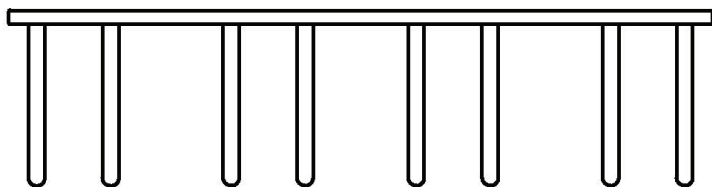

Perspective

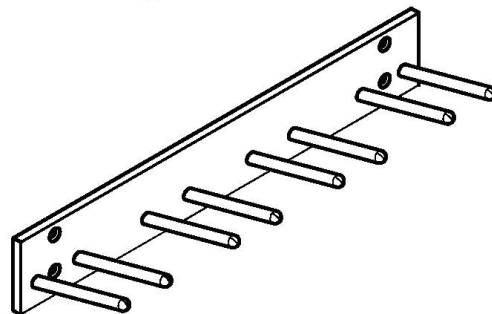

Front

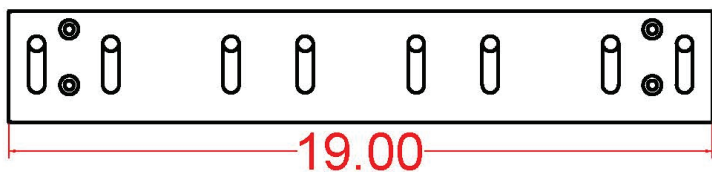

Side

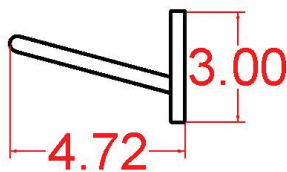

RAR-P4

SCALE: 3" = 1'

**PRODUCT INFORMATION**  
WALL MOUNTED LEAD APRON PEG RACK

**RAR-P7**

**Perspective**

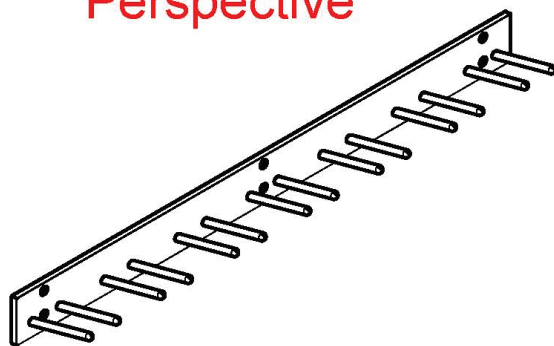

**Top**

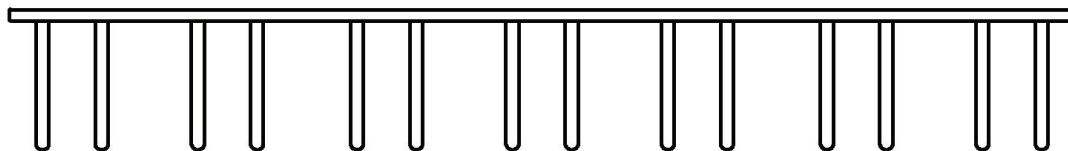

**Front**

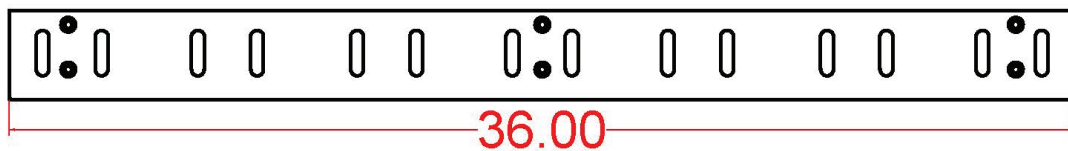

**Side**

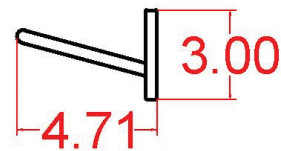

**RAR-P7**  
**SCALE: 3" = 1'**

**PRODUCT INFORMATION**  
WALL MOUNTED LEAD APRON PEG RACK

**RAR-P9**

**Perspective**

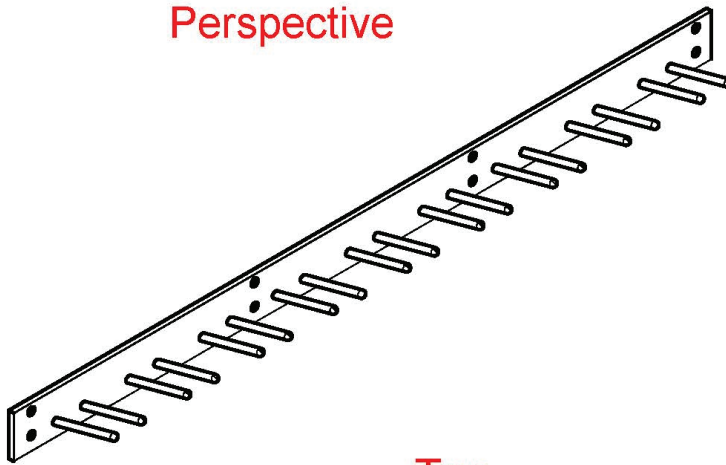

**Top**

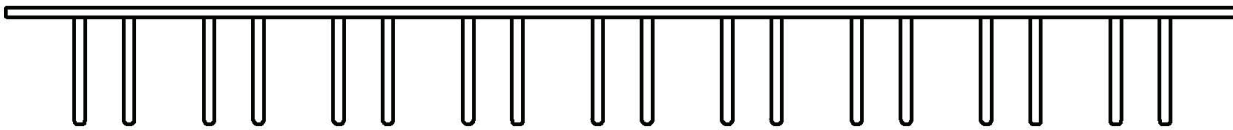

**Front**



**Side**

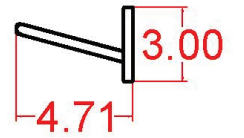

**RAR-P9**  
**SCALE: 1:6**

# CONTACT

Should you need any further information,  
please do not hesitate to contact us.

123 Lincoln Blvd, Middlesex, NJ 08846, USA 

+1 866 575 1307 

service@phillips-safety.com 

www.phillips-safety.com 