



ASSEMBLY INSTRUCTIONS

8-PEG SPYDER APRON RACK WITH GLOVE HOLDER



ABOUT PHILLIPS SAFETY

Phillips Safety is the industry leader in occupational safety eyewear. In business for over 100 years, you are being served with the dedication and craftsmanship of a family owned company.

Phillips Safety has been producing occupational safety glasses since 1905 and continues to develop and produce the highest quality glasses and lenses today. A leading manufacturer of specialty safety eyewear in the United States, Phillips Safety adheres to strict ANSI Z87-2+ and EN 207 CE standard certifications, holding itself to the highest

standard and prides itself on producing glasses with the finest quality materials available.

All safety glasses produced and sold by Phillips Safety meet strict industry standards for military, medical, research laboratories, and a variety of other industries.

With Phillips Safety's dedicated team, you can rest assured knowing that all your prescription safety needs are met.

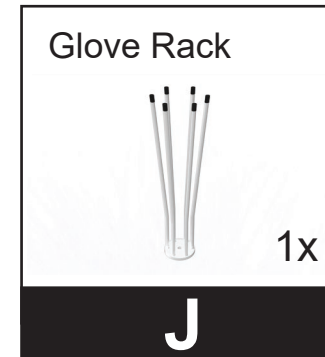
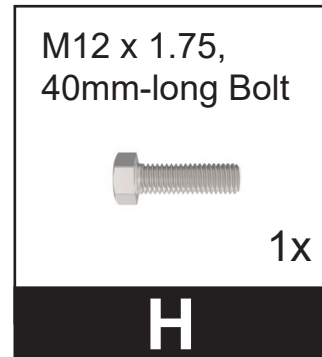
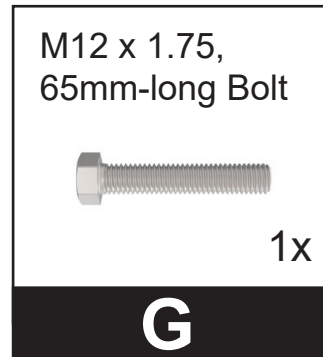
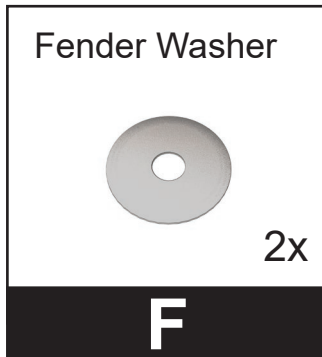
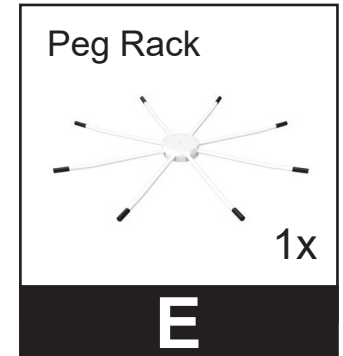
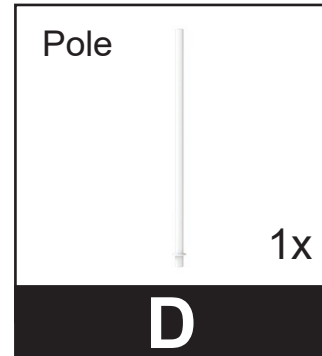
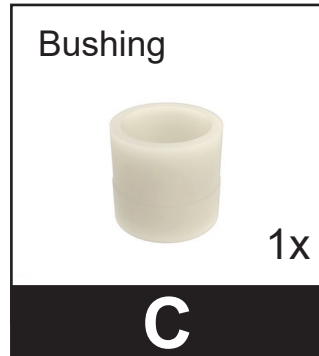
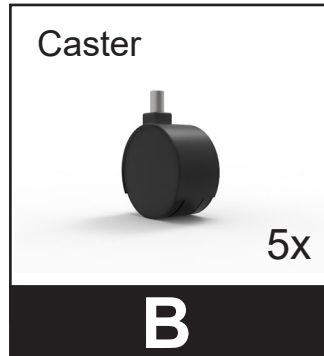
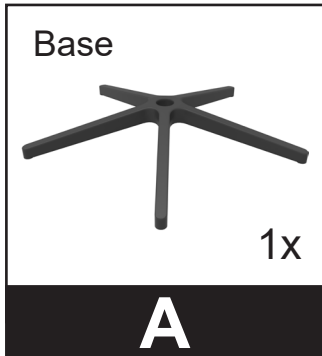

ASSEMBLY INSTRUCTIONS
8-PEG SPYDER APRON RACK WITH GLOVE HOLDER

STEP 1

1. Attach the caster wheel **B** to the base **A** by pushing the caster stem into the hole at the end of the base's leg.

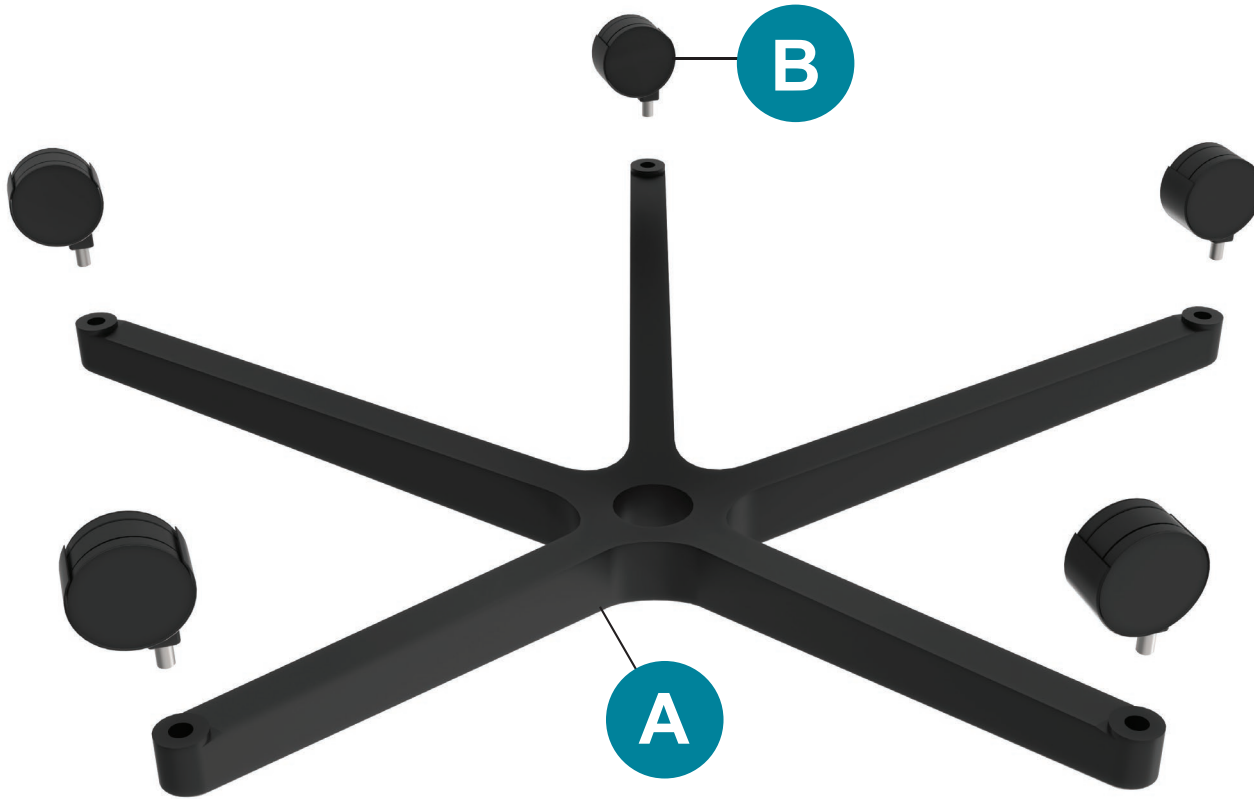

PARTS NEEDED

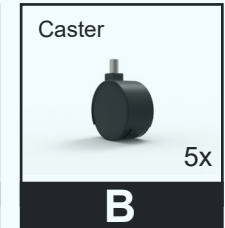
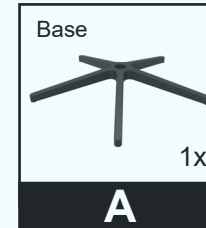

BASE



ASSEMBLY INSTRUCTIONS
8-PEG SPYDER APRON RACK WITH GLOVE HOLDER

STEP 2

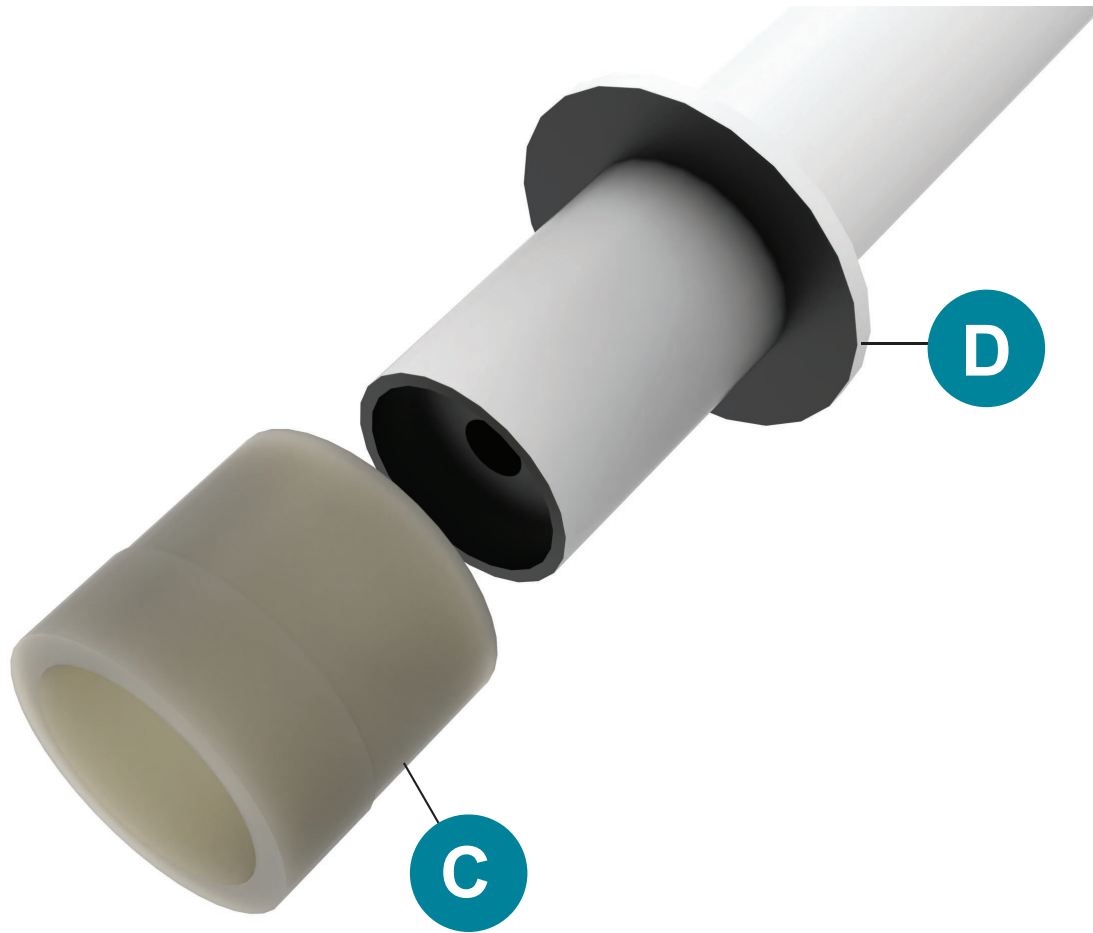
2. Slide the bushing **C** on the end of the pole **D** that has the stopper.



PARTS NEEDED

Bushing	Pole
	
1x	1x
C	D

CENTER POST



ASSEMBLY INSTRUCTIONS
8-PEG SPYDER APRON RACK WITH GLOVE HOLDER

STEP 3

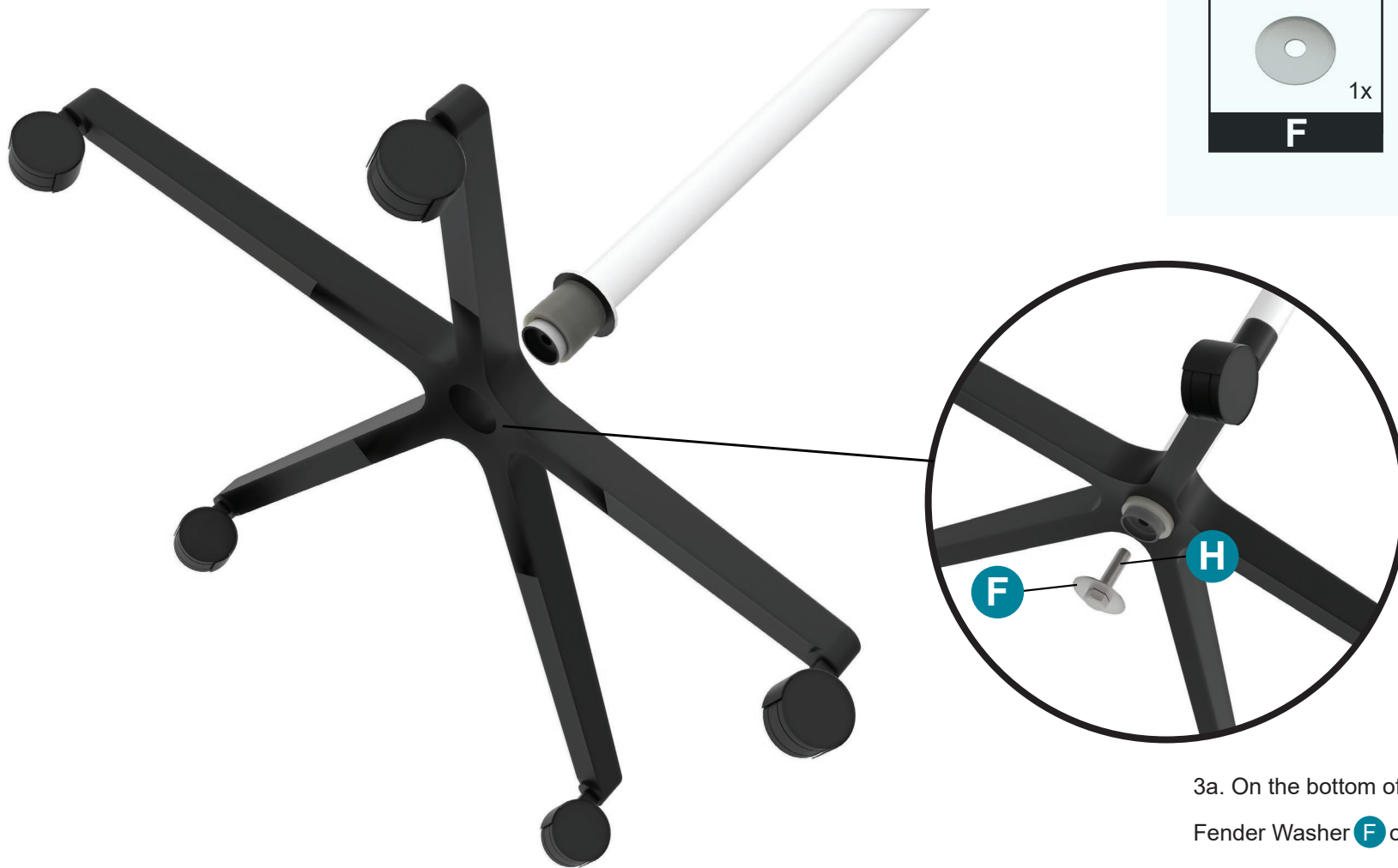
3. Insert the pole and the bushing into the top of the base.



PARTS NEEDED

Fender Washer  1x F	M12 x 1.75, 40mm-long Bolt  1x H
--	--

3a. On the bottom of the base, place a Fender Washer **F** on the small bolt **H** and tighten the bolt to the rod.

BASE + CENTER POST

PHILLIPS-SAFETY.COM



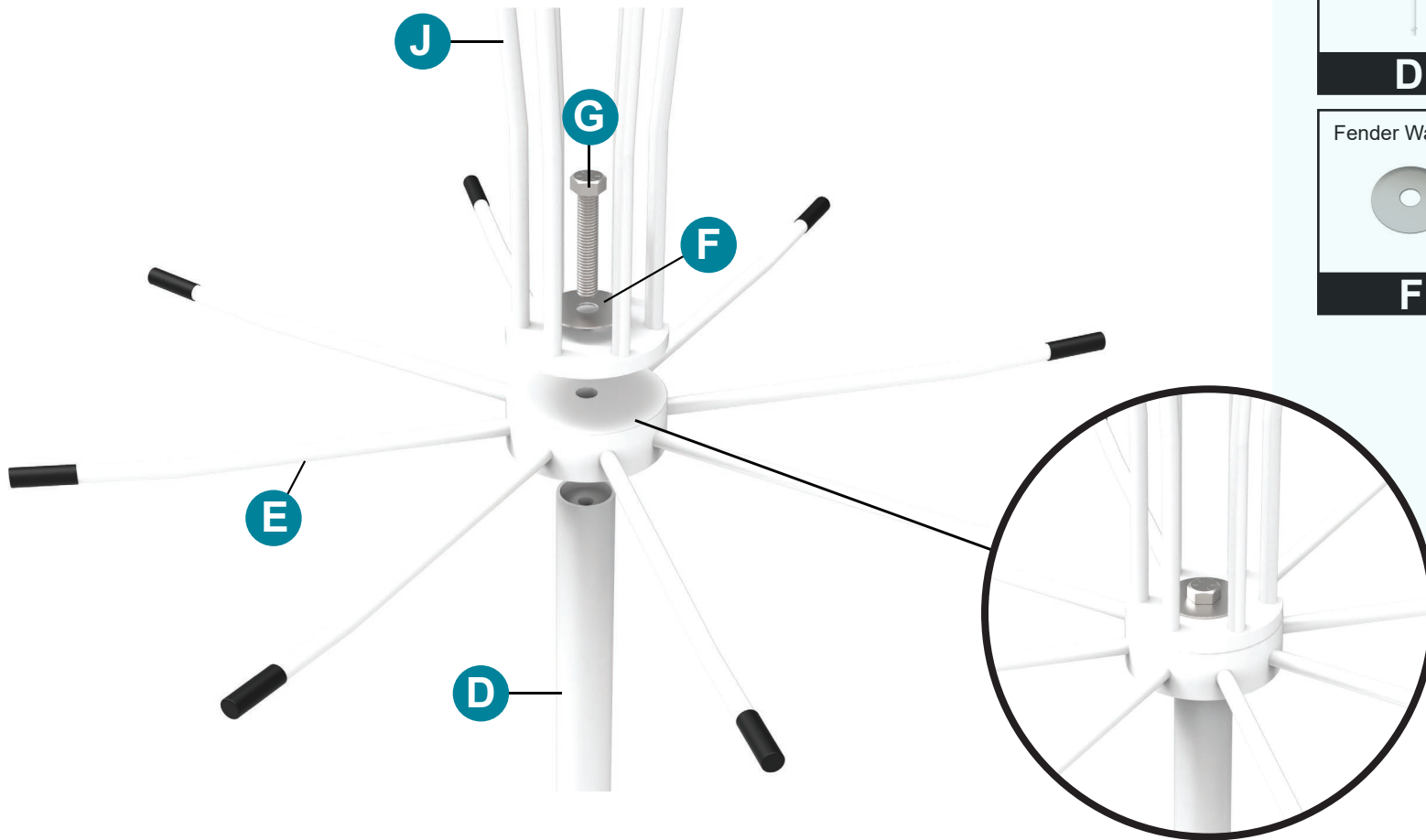

ASSEMBLY INSTRUCTIONS
8-PEG SPYDER APRON RACK WITH GLOVE HOLDER

STEP 4

4. Place the Peg Rack **E** and the Glove Rack **J** on top of the pole **D**.
Install the Fender Washer **F** and the 65mm bolt **G** and tighten.

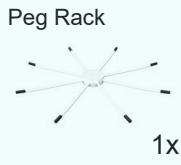

PARTS NEEDED

 Pole 1x D	 Peg Rack 1x E
 Fender Washer 1x F	 M12 x 1.75, 40mm-long Bolt 1x G
 Glove Rack 1x J	

GLOVE RACK

ASSEMBLY INSTRUCTIONS
8-PEG SPYDER APRON RACK WITH GLOVE HOLDER

STEP 5

The assembly is now complete.



FINAL PRODUCT

PHILLIPS-SAFETY.COM

ASSEMBLY INSTRUCTIONS
8-PEG SPYDER APRON RACK WITH GLOVE HOLDER

CONTACT

Should you need any further information,
please do not hesitate to contact us.

123 Lincoln Blvd, Middlesex, NJ 08845, USA 

+1 (866) 757 1307 

service@phillips-safety.com 

www.phillips-safety.com 